

ROSIE LI



Ginkgo Blossom 05 Chandelier Installation Instructions

SAFETY

THIS PRODUCT MUST BE INSTALLED IN ACCORDANCE WITH THE APPLICABLE INSTALLATION CODE BY A PERSON FAMILIAR WITH THE CONSTRUCTION AND OPERATION OF THE PRODUCT AND THE HAZARDS INVOLVED

BE SURE THE ELECTRICITY TO THE WIRES YOU ARE WORKING ON IS SHUT OFF; EITHER THE FUSE IS REMOVED OR THE CIRCUIT BREAKER IS TURNED OFF. TURNING THE POWER OFF USING THE LIGHT SWITCH IS NOT SUFFICIENT TO PREVENT ELECTRICAL SHOCK.

WARNING! – TO REDUCE THE RISK OF FIRE, ELECTRIC SHOCK, OR PERSONAL INJURY:

Turn off/unplug lamp and allow to cool before replacing bulb.

Do not look directly at lighted bulb.

Keep materials that burn easily away from lighted bulb.

Improper use of the bulbs can result in shattering, causing injury and equipment damage.

NOTE: The important safeguards and instructions appearing in this manual are not meant to cover all possible conditions or situations that may occur. It must be understood that common sense, caution, and care, are factors which cannot be built into any product. These factors must be supplied by the person(s) installing this unit.

Please read through all instructions carefully before attempting fixture installation.

Leaf and Glass parts to be applied to fixture AFTER ceiling mount installation.

Always wear provided gloves when handling fixture. To avoid damage to metal finish, keep fixture wrapping intact during installation; unwrap areas as needed.

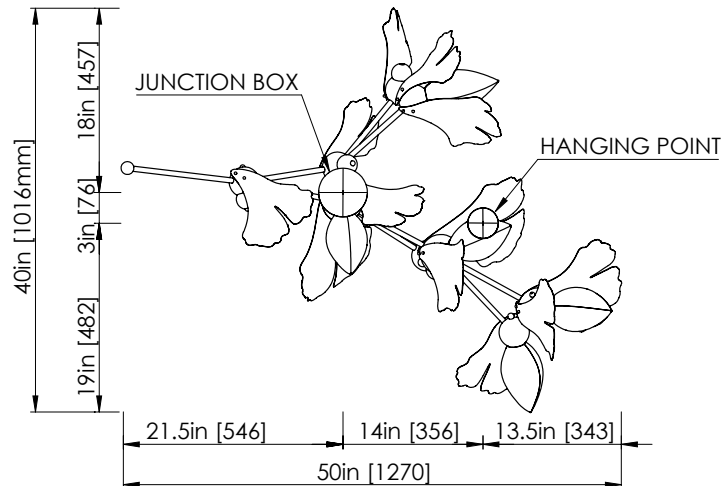

- 1) Install hanging stem to fixture. Feed electrical wires from fixture to hanging stem, screw on until fully tightened.
- 2) Locate canopy hanging hardware. Carefully slip the screw collar onto hanging stem, followed by the canopy. Avoid scratches to the metal surface finish.
- 3) Prepare the junction box to receive the cross bar.
- 4) Locate secondary hanging hub and hardware.
- 5) Install connection plate onto ceiling.

Cable Gripper Hardware

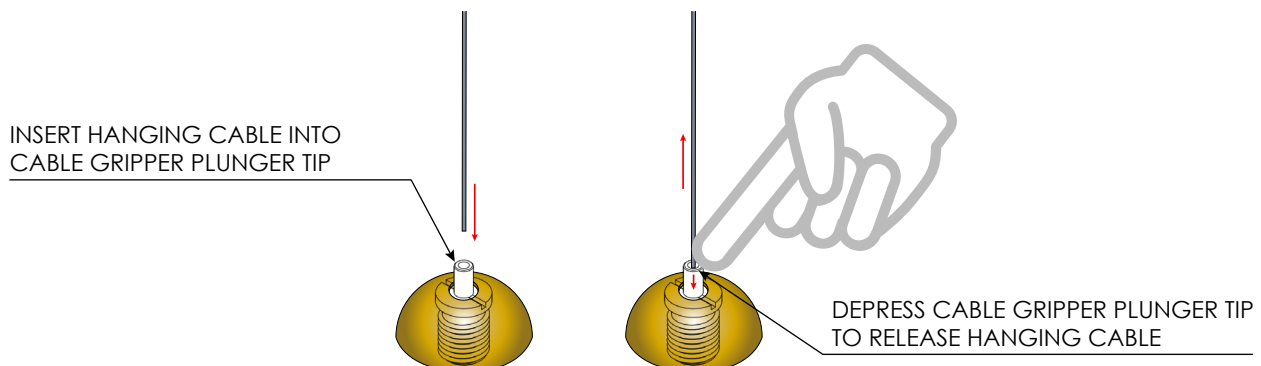

NOTE: Cable cannot bear weight to release

SECONDARY HANGING CONNECTION FOR LARGE BLOSSOM FIXTURES

DIMENSIONS IN INCHES[mm]

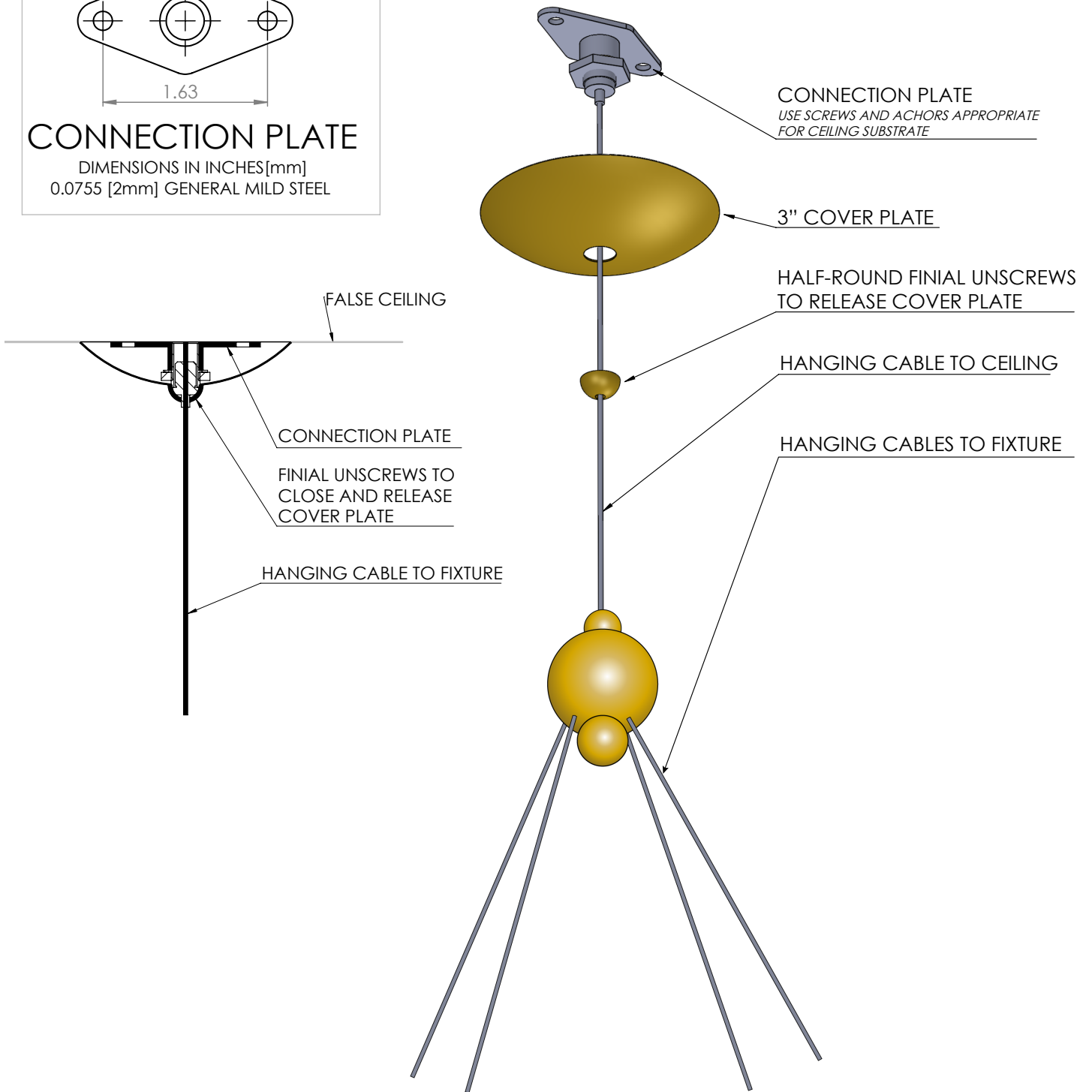
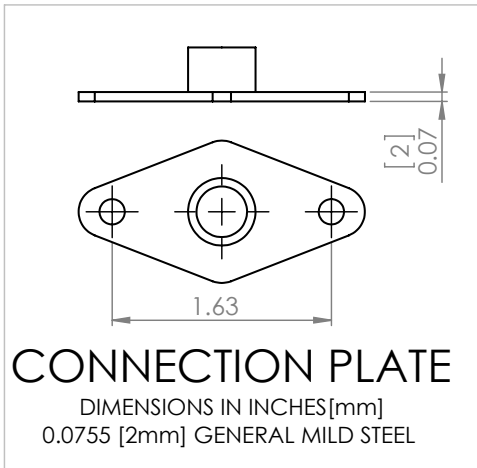

- 6) Thread hanging cable on secondary hanging hub through half-round finial and 3" cover plate. See pg. 3 drawing. Insert hanging cable into connection plate cable gripper.
- 7) Secure crossbar to hanging stem as illustrated in below diagram. Install crossbar to junction box and make electrical connections following the steps below.
- 8) Connect the NEUTRAL (white) fixture wire to the NEUTRAL (white) wire of the supply circuit and secure.
- 9) Connect the HOT (black) fixture wire to the HOT (black) wire of the supply circuit and secure.
- 10) Place wiring back in the junction box.
- 11) Bring canopy flush with ceiling to close junction box. Affix canopy position with screw collar.
- 12) Bring 3" cover plate flush with ceiling. Affix position with half-round finial. See diagram pg 2 for adjusting air craft cable and cable gripper hardware.
- 14) Install leaves using 2x Thumbscrew Balls. Thumbscrews Balls are on shipped on the fixture, remove each set prior to installing leaf. Leafs are numbered and labeled. Note: leaf orientation matches stickered number orientation on fixture frame.

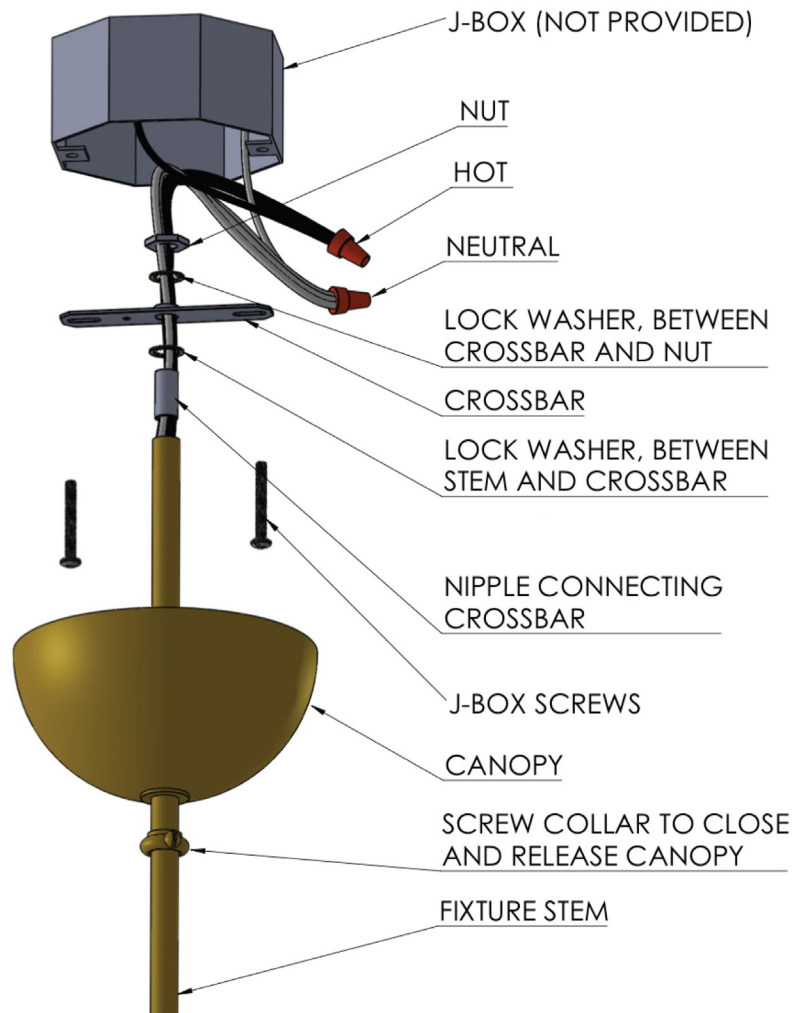

15) Install bulbs.

16) Install glass by slipping over bulbs and screwing in. Screw glass in fully, DO NOT overtighten.

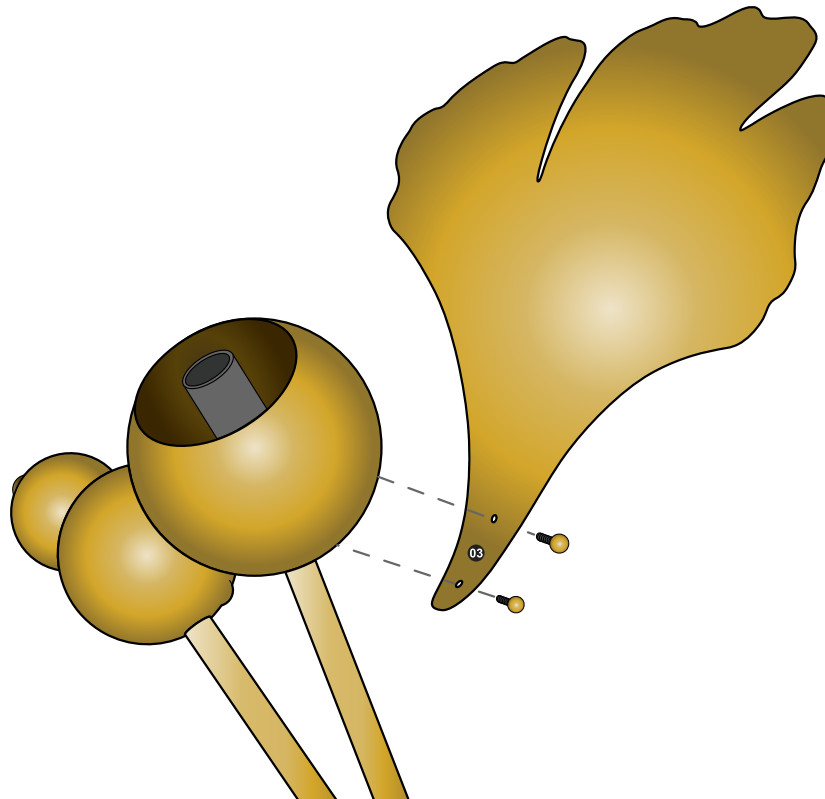

Installing Light Bulbs + Glass

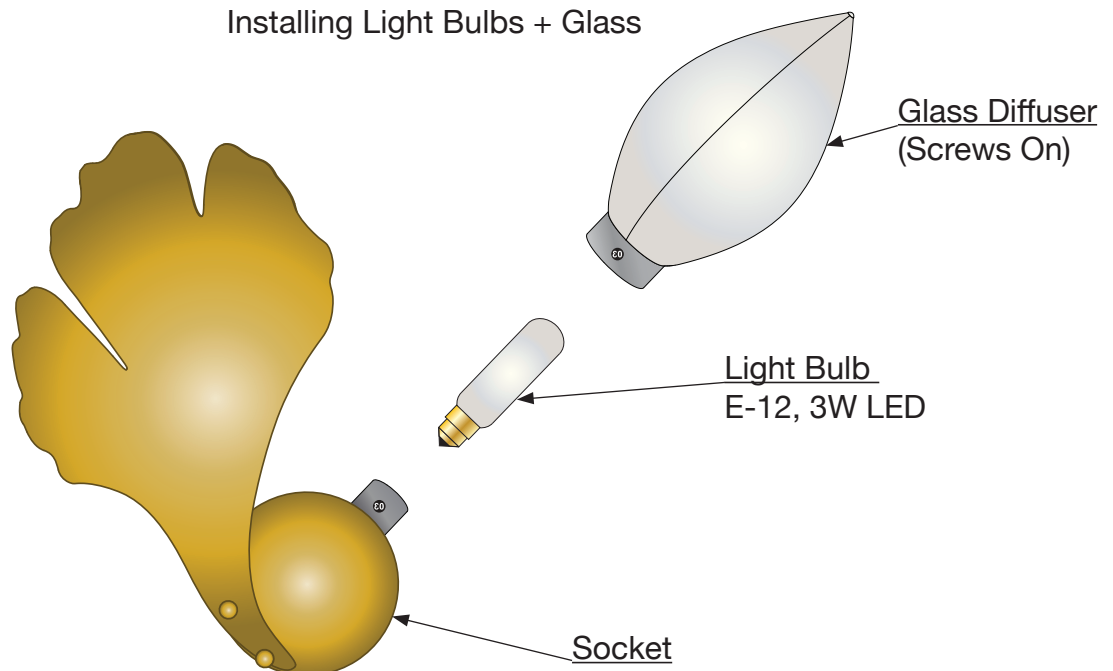

CLEANING

Use only soft, dry cloth to dust and clean fixture. Regular cleaning and routine maintenance will reduce the need for deep cleaning. Avoid use of chemicals or abrasive cleaners as it may damage metal and glass finish.